

GYNECOLOGY/OBSTETRICS INSTRUMENTS

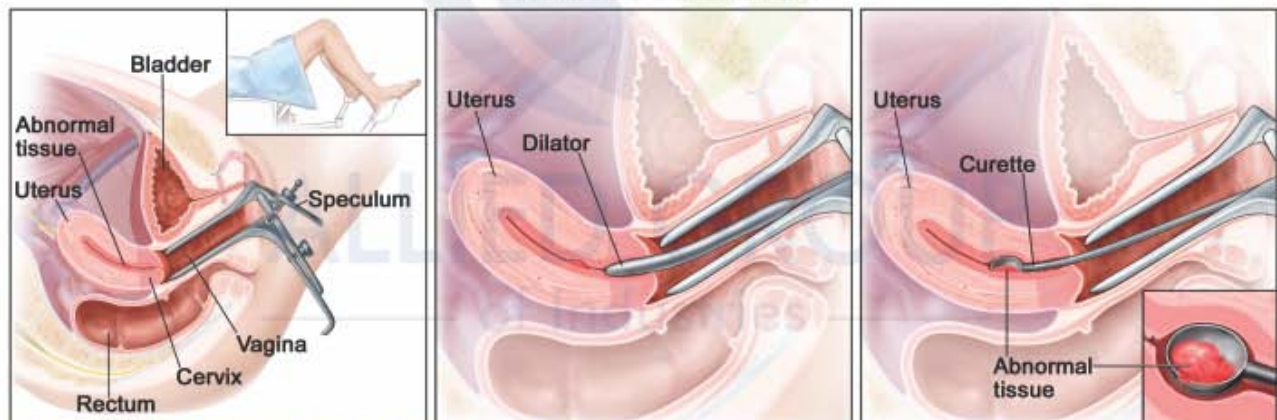

Dilatation and Curettage



VAGINAL SPECULUM

Scheidenspekulum | Espéculo vaginal
Spéculum vaginal | Speculum vaginale



Cusco vaginal speculum
17-001 75 mm x 32 mm
17-002 85 mm x 35 mm
17-003 100 mm x 35 mm
17-004 75 mm x 17 mm
for virgins



Cusco vaginal speculum
17-005 75 mm x 32 mm
17-006 80 mm x 35 mm
17-007 100 mm x 37 mm



Cusco vaginal speculum
17-008 80 mm x 22 mm
17-009 100 mm x 25 mm
17-010 105 mm x 27 mm
Swiss pattern



Grave vaginal speculum
17-011 75 mm x 20 mm
17-012 95 mm x 35 mm
17-013 115 mm x 35 mm



Pederson vaginal speculum
17-014 75 mm x 13 mm
17-015 100 mm x 22 mm
17-016 120 mm x 25 mm



Winterton
17-017



Trelat vaginal speculum
17-018 85 mm x 30 mm
17-019 95 mm x 35 mm
17-020 115 mm x 43 mm



Vaginal Speculum Cusco
17-021 Extra Small
17-022 Small
17-023 Medium
17-024 Medium Extra long
17-025 Large



Semm vaginal speculum
17-026 90 mm x 14 / 18 mm
17-027 100 mm x 17 / 20 mm
17-028 110 mm x 25 / 30 mm

VAGINAL SPECULUM

Scheidenspekulum | Espécúlo vaginal
Spéculum vaginal | Speculum vaginale



Collin vaginal speculum
17-029 85 mm x 30 mm
17-030 100 mm x 35 mm
17-031 110 mm x 40 mm



COLLIN
17-032
55 x 10 mm



NOTT
17-033 90 mm 30 mm
17-034 100 mm 30 mm



DE VILBISS
17-035
4 x 27 mm
102 mm x 32 mm
Medium



SEYFFERT
17-036 100 x 24 mm
17-037 110 x 32 mm
23 cm, 9"



CUSCO
17-038 75 x 32 mm
17-039 85 x 35 mm
17-040 100 x 35 mm



CUSCO
17-041 75 x 17 mm



CUSCO
17-042 90 x 22 mm
17-043 100 x 25 mm
17-044 105 x 27 mm



GRAVES
Virgin Speculaums
Color Coated, Straight
17-045 20mm x 75mm, Small
17-046 35mm x 95mm, Medium
17-047 35mm x 115mm, Large



Graves Vaginal Speculum Leep / Lietz
17-048 Small
17-049 Medium
17-050 Large
17-051 X-large

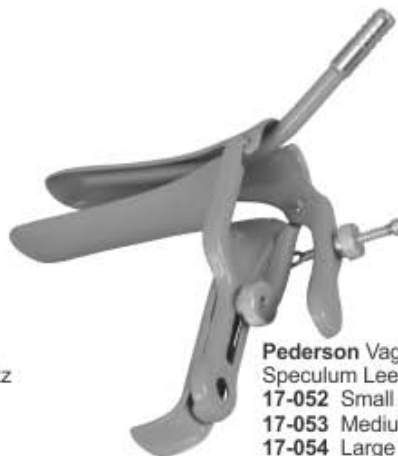

Pederson Vaginal Speculum Leep / Lietz
17-052 Small
17-053 Medium
17-054 Large
17-055 X-Large



PEDERSON
Virgin Speculaums
Color Coated
17-056 17mm x 100mm, Narrow
17-057 13mm x 75mm, Small
17-058 22mm x 100mm, Medium
17-059 25mm x 120mm, Large

VAGINAL RETRACTORS

Vaginal Retraktoren | Retractores vaginales

Écarteurs vaginaux | Divaricatori vaginali



NEW PORT
17-060
25 cm



**Lateral Vaginal
Retractor**
17-061
21 cm



**Lateral Vaginal Retractor
Blue Coated Leep / Lietz**
17-062 21 cm



Side Wall Retractors
17-063 4-Sided Pederson Speculum, Medium
17-064 4-Sided Pederson Speculum, Large
Redundant Wall Retractor, 3.5 in. x .75 in. blades
LateralWall Retractor, Closed Shanks, 2.25 in. blades
LateralWall Retractor, Open Shanks, 2.5 in. blades



Lateral Vaginal Retractor
Blue Coated
17-065 26cm



**McGee Lateral
Vaginal Retractor
With Ratchet Handle**
17-066 20cm

VAGINAL SPECULUM

Scheidenspekulum | Espécúlo vaginal
Spéculum vaginal | Speculum vaginae



**Kogan Speculum
17-067**
24 cm
with scale-ratchet
and fixation screw



**Kogan Speculum
17-068**
24 cm



**Kogan - Modif.
Speculum**
28 cm
17-069
x=4 mm y=8mm
17-070
x=2 mm y=4mm



**Kogan Endocervical Spatula
17-071**
Ratchet, Standard Tips, 28cm
Ratchet, Narrow Tips, 28cm
Set Screw, Standard Tips, 28cm
Set Screw, Narrow Tips, 28cm



**RAMATHIBODI
17-072**
27.5 cm
Uterine Manipulator



**RAMATHIBODI
17-073**
25 cm
Tubal hook



Kristeller Speculum
17-074 70 mm x 27 mm
17-075 80 mm x 30 mm
17-076 90 mm x 36 mm
17-077 110 mm x 27 mm
17-078 110 mm x 30 mm
17-079 110 mm x 36 mm



Kristeller Retractor
17-080 75 mm x 23 mm
17-081 85 mm x 26 mm
17-082 100 mm x 32 mm
17-083 115 mm x 23 mm
17-084 115 mm x 26 mm
17-085 115 mm x 32 mm



Kristeller Speculum & Retractor
17-086 75 mm x 23 mm
17-087 85 mm x 26 mm
17-088 100 mm x 32 mm
17-089 115 mm x 23 mm
17-090 115 mm x 26 mm
17-091 115 mm x 32 mm



Kristeller Speculum
17-092 105 mm x 18 mm
17-093 105 mm x 21 mm
 Speculum tapered, for virgins



Kristeller Retractor
17-094 110 mm x 14 mm
17-095 115 mm x 17 mm



Kristeller Speculum & Retractor
17-096 110 mm x 14 mm
17-097 115 mm x 17 mm

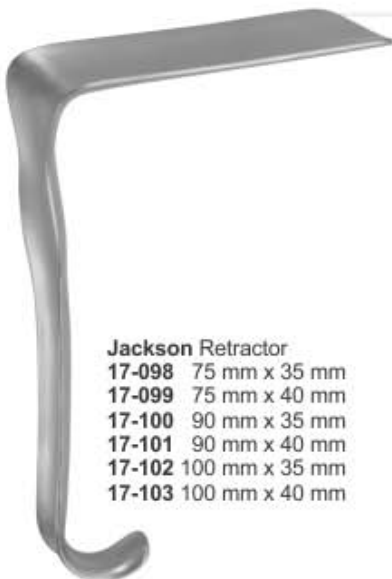

Jackson Retractor
17-098 75 mm x 35 mm
17-099 75 mm x 40 mm
17-100 90 mm x 35 mm
17-101 90 mm x 40 mm
17-102 100 mm x 35 mm
17-103 100 mm x 40 mm



Sims Speculum & Retractor
17-104 70 mm x 25 mm / 30 mm
17-105 75 mm x 30 mm / 35 mm
17-106 80 mm x 35 mm / 40 mm

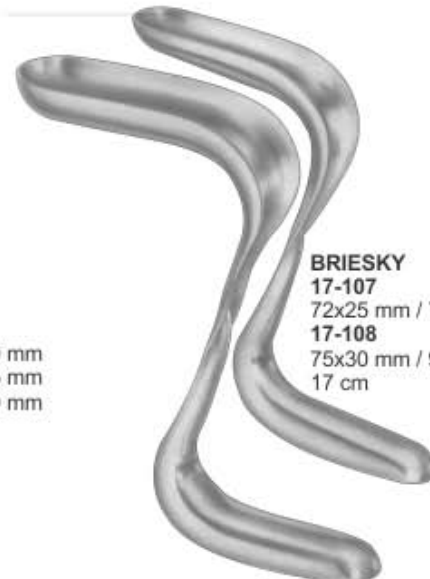

BRIESKY
17-107
 72x25 mm / 77x30 mm
17-108
 75x30 mm / 92x38 mm
 17 cm

VAGINAL SPECULUM AND RETRACTORS

Vaginalspekulum und Retraktoren | Espécúlo vaginal y retractores
 Spécúlum et écarteurs vaginaux | Speculum vaginale e divaricatori



Kallmorgen Speculum
 17-109 70 mm x 40 mm
 17-110 90 mm x 40 mm



Kallmorgen & Retractor
 17-111 70 mm x 33 mm
 17-112 90 mm x 33 mm



Kallmorgen Speculum & Retractor
 17-113 70 mm x 33 mm
 17-114 90 mm x 33 mm



MATHIEU Vaginal Speculum
 17-115
 Set 100x13mm-23mm
 17-116
 95x16mm-26mm
 17-117
 95x26mm-30 mm
 21 cm



MATHIEU Vaginal Retractor
 17-118
 Set 100x17mm-30mm
 17-119
 100x11mm-20mm
 17-120
 100x14mm-26mm
 22 cm



Doyen Vaginal Speculum
 22 cm



Slightly Concave

- 17-121 60 x 35 mm
- 17-122 90 x 35 mm
- 17-123 120 x 35 mm
- 17-124 60 x 45 mm
- 17-125 90 x 45 mm
- 17-126 120 x 45 mm
- 17-127 160 x 45 mm
- 17-128 60 x 60 mm
- 17-129 90 x 60 mm
- 17-130 120 x 60 mm
- 17-131 160 x 60 mm



Landon Vaginal Retractor
 17-132
 Blade 9 cm
 Deep 2.5 cm wide.



BRAUN 17-133
 18 cm



BRAUN 17-134
 18 cm



17-135
 Handle with cold light carrier for upper blades
 28 cm



17-136
 115 x 22 mm
17-137
 115 x 26 mm

SIMON
 115 x 22 mm
 27.5 cm



VAGINAL SPECULUM

Scheidenspekulum | Espéculo vaginal
 Spéculum vaginal | Speculum vaginale



**Scherback Speculum
 17-160**
 Set consisting of:
 handle weight 5 blades



17-161
 80 x 30 mm



17-162
 85 x 35 mm



17-163
 85 x 40 mm



17-164
 55 x 40 - 60 mm



17-165
 70 x 45 - 70 mm



**Scherback Speculum
 17-166**
 Set consisting of:
 2 handle, 8 blades



17-167
 80 x 30 mm



17-171
 65 x 30 mm



17-168
 85 x 33 mm



17-172
 75 x 35 mm

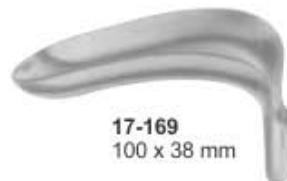

17-169
 100 x 38 mm



17-173
 85 x 35 mm



17-170
 110 x 42 mm



17-174
 95 x 35 mm

SPECULUM RETRACTORS

Spekulumspreizer

Retradores de espéculo

Écarteurs de spéculum

Divaricatori per speculum

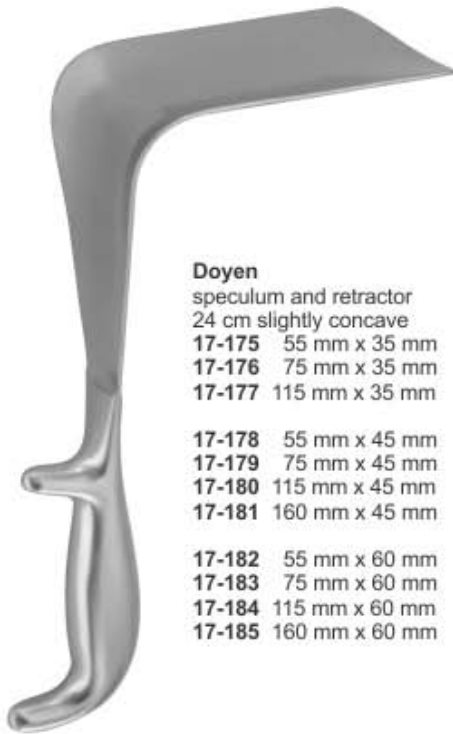

Doyen

speculum and retractor
24 cm slightly concave

- 17-175 55 mm x 35 mm
- 17-176 75 mm x 35 mm
- 17-177 115 mm x 35 mm

- 17-178 55 mm x 45 mm
- 17-179 75 mm x 45 mm
- 17-180 115 mm x 45 mm
- 17-181 160 mm x 45 mm

- 17-182 55 mm x 60 mm
- 17-183 75 mm x 60 mm
- 17-184 115 mm x 60 mm
- 17-185 160 mm x 60 mm



Doyen

speculum and retractor
24 cm medium concave

- 17-186 55 mm x 35 mm
- 17-187 75 mm x 35 mm
- 17-188 115 mm x 35 mm

- 17-189 55 mm x 45 mm
- 17-190 75 mm x 45 mm
- 17-191 115 mm x 45 mm

- 17-192 55 mm x 60 mm
- 17-193 75 mm x 60 mm
- 17-194 115 mm x 60 mm



17-195
60 x 45 mm



17-196
90 x 45 mm



17-197
112 x 45 mm

DOYEN

Speculum & Retractor
23.5 cm



**Garrigue Weighted
Vaginal Speculum**
17-198 4.0 cm x 8.0 cm
Weight 2 lbs



**Henrotin Weighted
Vaginal Speculum**
17-199 3.8 cm x 9.0 cm
Weight 3 lbs.



AUVARD,
speculum & retractor
17-200
80 x 38 mm - 28 mm
1,530 kg
with fixed weight
23 cm



AUVARD
speculum & retractor
17-201 75 x 42 mm
17-202 80- x 43 mm
(40 mm)
17-203 105 x 43 mm
(40 mm)
with detachable weight
23 cm



WEISSBARTH
speculum & retractor
17-204 80 x 28 mm
17-205 85 x 42 mm
21 cm

Scheidenspekulum | *Espéculo vaginal*
Spéculum vaginal | *Speculum vaginale*



**AUVARD
17-206**
65 x 38 mm - 28 mm
1,530 kg
with fixed weight
23 cm



**MARTIN
17-207**
with hook shaped
handle for hanging
in weights
27 cm



STEINER SPECULUM
Ideal for deep vaginal surgery.
Blades may be ordered from
4" to 7", 5.5" is normal length.

17-208
1.1 Kg / 2.5 lb:
14 cm x 3 cm



HARDY-DUDDY SPECULUM
It will not fall out. Design places the 3.5 lbs
weight at a right angle to the shaft of the
speculum, preventing expulsion. Many
blade options are available.

17-209
Hardy-Duddy Speculum,
3.5 lbs., 120 mm x 35 mm
cupped blade



AUVARD SPECULUM
An assortment of weighted
Auvard specula is available.

17-210
1.1 Kg / 2.5 lb:
8.5 cm x 4 cm
17-211
1.1 Kg / 2.5 lb:
10 cm x 4.5 cm



**NICHOLS WEIGHTED
SPECULUM**
Permits retraction of posterior
vaginal wall, while providing
suction and measurement of
fluids from the surgical site.

17-212
Nichols Vaginal Weighted Speculum
with Suction, 2.5 lbs. 7cm x 3.8cm

VAGINAL RETRACTORS

Vaginal Retraktoren | Retractores vaginales
Écarteurs vaginaux | Divaricatori vaginali



**O'Sullivan - O'Connor
Vaginal Retractor**
17-213 Set of 3 Complete



17-214
45 x 17 mm



17-215
90 x 45 mm



Abdominal Retractor
17-217 9 cm wide
17-218 10 cm wide
17-219 11.5 cm wide



17-216
90 x 37 mm



Friedmann Retractor
17-220
10 cm



COMYN BERKELEY
Vulva Self Retaining



17-221
15.5cm



DOYEN
Supra Hollow Handle
17-222 7.5mm x 28cm
17-223 9mm x 28cm
17-224 10mm x 28cm
17-225 11.5mm x 28cm



DOYEN POZZI
Retractor
17-226 4.5mm x 5mm x 25.5cm
17-227 4.5mm x 9mm x 25.5cm
17-228 4.5mm x 11.5mm x 25.5cm

CERVICAL BIOPSY AND SPECIMEN FORCEPS

Probeexzisionszangen | Pinzas saca-bocados para biopsia
 Pincas emporte-pièces à biopsie | Pinze taglianti per biopsia



Berger
 Biopsy and Specimen Forceps
 17-229
 x = 200 mm



Eppendorfer
 Biopsy and Specimen Forceps
 17-230
 x = 200 mm

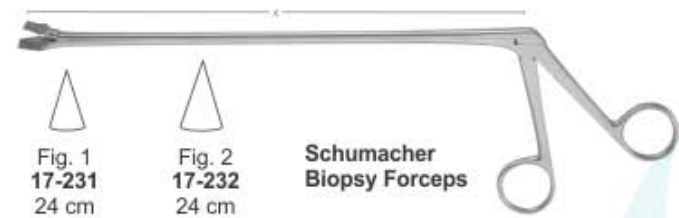

Fig. 1 17-231 24 cm
 Fig. 2 17-232 24 cm
Schumacher Biopsy Forceps



Kevorkian
 Biopsy and Specimen Forceps
 17-233
 x = 245 mm



Alexander
 Biopsy and Specimen Forceps
 17-234 28 cm
 x = 200 mm

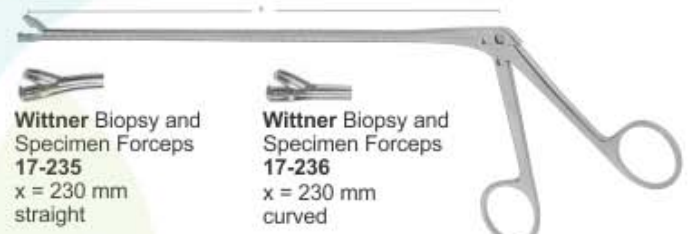

Wittner Biopsy and Specimen Forceps
 17-235 x = 230 mm straight
Wittner Biopsy and Specimen Forceps
 17-236 x = 230 mm curved



Schumacher
 Biopsy and Specimen Forceps
 17-237 x = 23 cm complete
 17-238 x = 23 cm tip



Tischler - Morgan
 Biopsy and Specimen Forceps
 USA Modell
 17-239 x = 200 mm
 17-240 x = 250 mm
Tischler - Morgan
 Biopsy and Specimen Forceps
 17-241 x = 200 mm
 17-242 x = 250 mm

Instruments as illustrated, but without locking screw. USA Modell



Mini - Tischler
 Biopsy and Specimen Forceps
 17-243 x = 200 mm
 17-244 x = 250 mm
Mini - Tischler
 Biopsy and Specimen Forceps
 17-245 x = 200 mm
 17-246 x = 250 mm

Instruments as illustrated, but without locking screw.

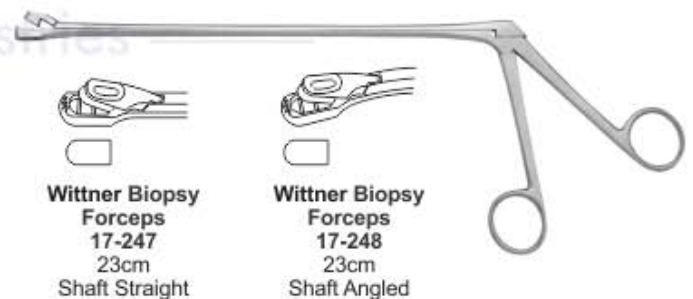

Wittner Biopsy Forceps
 17-247 23cm Shaft Straight
Wittner Biopsy Forceps
 17-248 23cm Shaft Angled

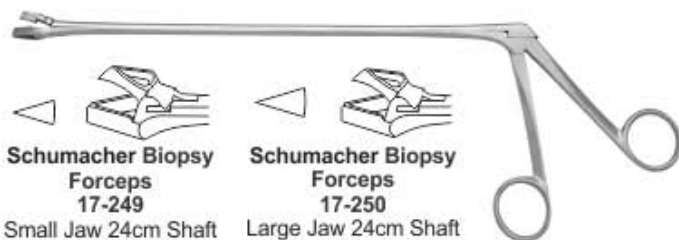

Schumacher Biopsy Forceps
 17-249 Small Jaw 24cm Shaft
Schumacher Biopsy Forceps
 17-250 Large Jaw 24cm Shaft



Tischler Baby Biopsy Forceps
 17-251 21.5cm Shaft

Probeexzisionszangen

Pinzas saca-bocados para biopsia

Pinces emporte-pièces à biopsie

Pinze taglianti per biopsia



Tischler Biopsy Forceps
17-252
21.5cm Shaft



Burke Biopsy Forceps
17-253
21.5cm Shaft

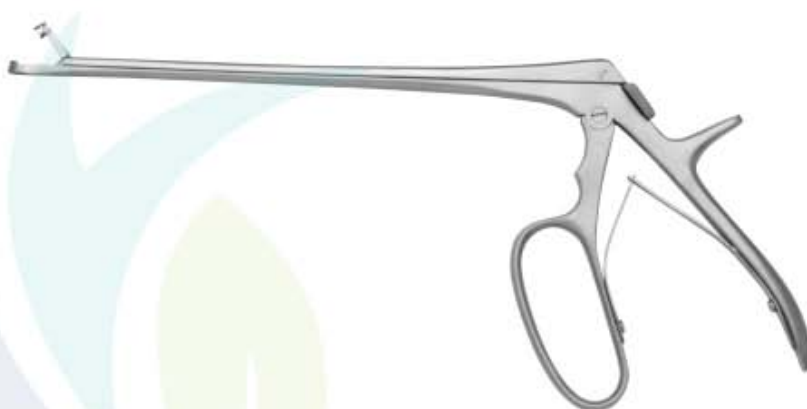

Eppendorf Biopsy Forceps
17-254
20cm Shaft



Kevorkian Young Biopsy Forceps
17-255
25.5cm Shaft

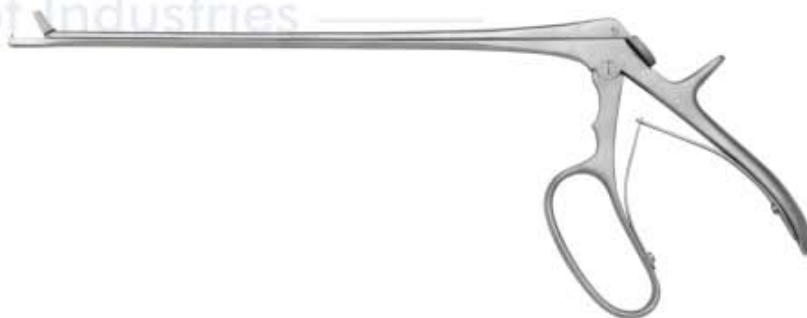

Leechwilkinson Biopsy Forceps
17-256
20cm Shaft Round



ALLIED GROUP
of Industries

CERVICAL BIOPSY AND SPECIMEN FORCEPS

Probeexzisionszangen

Pinzas saca-bocados para biopsia

Pinces emporte-pièces à biopsie

Pinze taglienti per biopsia



Uni - Tischler
Biopsy and
Specimen Forceps
17-258
3 x 7 mm
Straight, Tip only



Uni - Tischler
Biopsy and
Specimen Forceps
17-259
3 x 7 mm
up, Tip only



Uni - Tischler
Biopsy and
Specimen Forceps
17-260
3 x 7 mm
down, Tip only

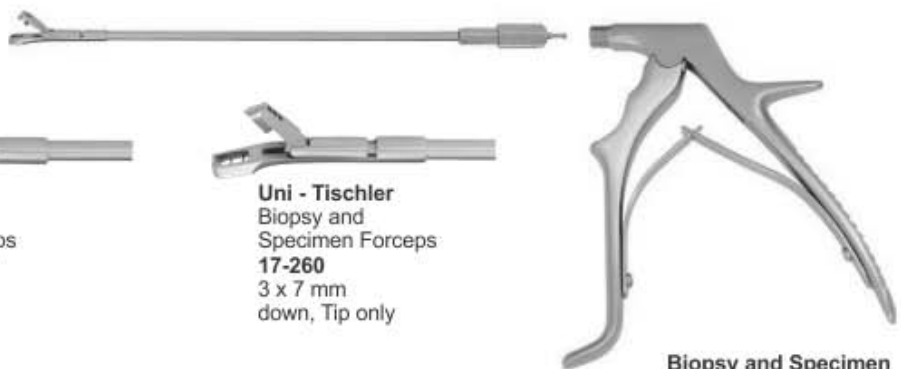

**Biopsy and Specimen
Forceps Handle only
17-257**



Uni - Townsend
Biopsy and
Specimen Forceps
17-261
2.3 x 4 mm
straight, Tip only



Uni - Townsend
Biopsy and
Specimen Forceps
17-262
2.3 x 4 mm
up, Tip only



Uni - Townsend
Biopsy and
Specimen Forceps
17-263
2.3 x 4 mm
down, Tip only



Uni - Kevorkian
Biopsy and
Specimen Forceps
17-264
3 x 9 mm
Tip only



Uni - Oval
Biopsy and
Specimen Forceps
17-265
3 x 5 mm
Tip only



Uni - Burke
Biopsy and
Specimen Forceps
17-266
3 x 5 mm
Tip only



Uni - Tischler
Biopsy and
Specimen Forceps
17-268
3 x 7 mm
Straight, Tip only



Uni - Tischler
Biopsy and
Specimen Forceps
17-269
3 x 7 mm
up, Tip only



Uni - Tischler
Biopsy and
Specimen Forceps
17-270
3 x 7 mm
down, Tip only



**Biopsy and Specimen
Forceps Handle only
17-267**



Uni - Townsend
Biopsy and
Specimen Forceps
17-271
2.3 x 4 mm
straight, Tip only



Uni - Townsend
Biopsy and
Specimen Forceps
17-272
2.3 x 4 mm
up, Tip only



Uni - Townsend
Biopsy and
Specimen Forceps
17-273
2.3 x 4 mm
down, Tip only

Uni - Kevorkian
Biopsy and
Specimen Forceps
17-274
3 x 9 mm
Tip only



Uni - Oval
Biopsy and
Specimen Forceps
17-275
3 x 5 mm
Tip only



Uni - Burke
Biopsy and
Specimen Forceps
17-276
3 x 5 mm
Tip only

Polypenfasszange, Darm-anastomosenklemmen

Pince Pour Saisir Polypes, Pinces-clamps Pour Anastomose Intestinale

Pinza Para Coger Pólipos, Clamps Para Anastomosis Intestinales

Pinze Per Afferrare Polipi, Pinze Per Anastomosi Intestinali

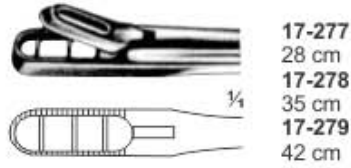
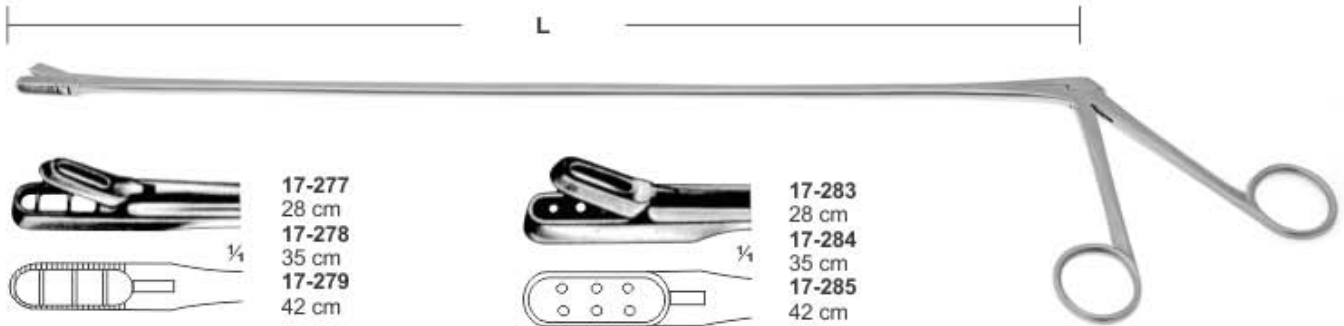

17-277
28 cm
17-278
35 cm
17-279
42 cm

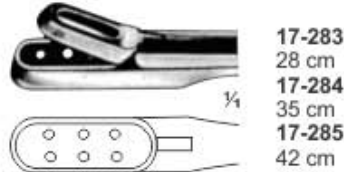

17-283
28 cm
17-284
35 cm
17-285
42 cm

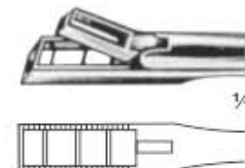

17-280
28 cm
17-281
35 cm
17-282
42 cm



17-286
28 cm
17-287
35 cm
17-288
42 cm



YEOMANN

PILE FORCEPS

COTTON CARRIER



LURE
17-289
24.5cm



JARVIS
17-290
23cm



LANGENBECK
17-291
45cm



17-292
45cm

CERVICAL BIOPSY AND SPECIMEN FORCEPS

Probeexzisionszangen

Pinzas saca-bocados para biopsia

Pinces emporte-pièces à biopsie

Pinze taglianti per biopsia



**Schubert
Biopsy Forceps**
17-293 21 cm
17-294 28 cm

**Faure Uterine
Biopsy Forceps**
17-295 21 cm



**Schubert
Biopsy Forceps**
17-296 26 cm



**Gellhorn
Biopsy Forceps**
17-297 23 cm



**Thoms-Gaylor
Biopsy Forceps**
17-298 22 cm
17-299 24 cm



**Van Doren
Biopsy Forceps**
17-300 24 cm



**Schumacher
Biopsy Forceps**

ALLIED GROUP
of Industries

Fig. 1
17-301
24 cm

Fig. 2
17-302
24 cm

Hakenzangen

Pinzas para coger el cuello del útero

Pinces pour l'abaissement du col de l'utérus

Pinze per abbassare il collo dell'utero



Museux Tenaculum Forceps



24 cm
17-303
8 mm
17-304
6 mm
17-305
10 mm
Straight

24 cm
17-306
8 mm
17-307
6 mm
17-308
10 mm
Curved



Jacobs Uterine Vulsellum Forceps

17-309
21 cm



17-310
21 cm



WINTER
17-311 Fig. 1
17-312 Fig. 2
17-313 Fig. 3
28 cm



Teale Tenaculum Forceps
17-314 23 cm



Pratt Tenaculum Forceps
17-315 26 cm



Czerny Tenaculum Forceps
17-316 20.5 cm



Schroeder Vulsellum Tenaculum Forceps



17-317 24 cm
17-318 24 cm

TENACULUM FORCEPS

Hakenzangen

Pinzas para coger el cuello del útero

Pinces pour l'abaissement du col de l'utérus

Pinze per abbassare il collo dell'utero



Pozzi Tenaculum Forceps
17-319 25.5 cm



Schroeder Tenaculum Forceps
17-320 25 cm



Duplay Tenaculum Forceps
17-321 28 cm



Iowa Tenaculum Forceps
17-322 26 cm



Skene Tenaculum Forceps
17-323 24 cm



Beacham Amniotome
17-324
26 cm

Staude - Moore Tenaculum Forceps
17-325 17 cm



Barrett Tenaculum Forceps
17-326 18 cm



Braun Tenaculum Forceps Sharp
17-327 25 cm



Schroeder-Braun Tenaculum Forceps Sharp
17-328 25 cm sharp

17-329
blunt

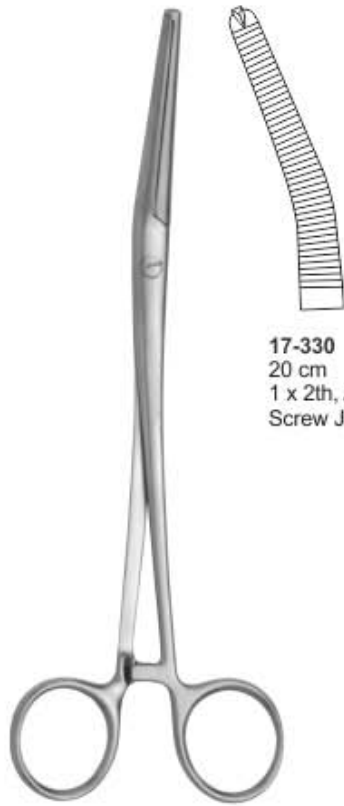

17-330
20 cm
1 x 2th, Angled
Screw Joint

BONNEY

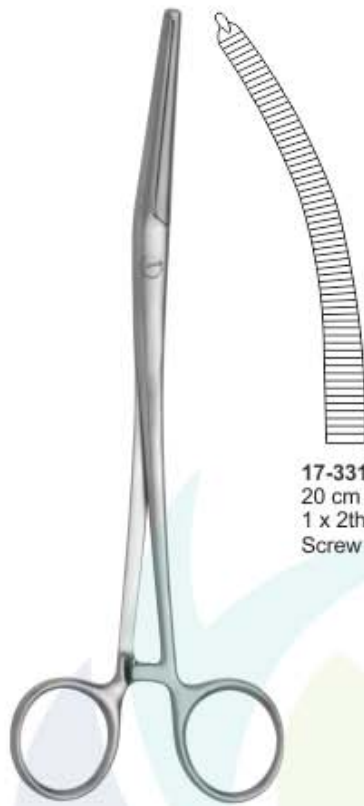

17-331
20 cm
1 x 2th, Curved
Screw Joint

BONNEY-BERKLEY

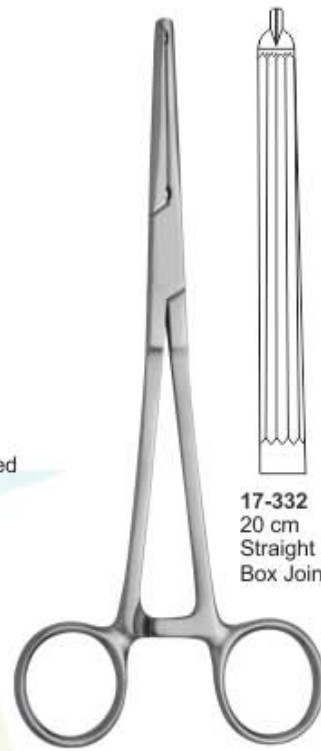

17-332
20 cm
Straight
Box Joint

GWILLIAM

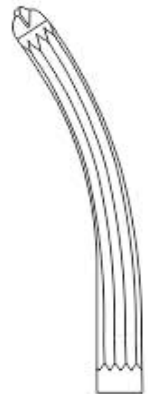

17-333
20 cm
Curved
Box Joint



17-334
20 cm
Curved
1 tooth
Box Joint

HEANEY



17-335
20 cm
Curved
2 Teeth
Box Joint



17-336
23 cm
Curved
Box Joint

HUNTER



17-337
20 cm
Straight
Box Joint

MAINGOT

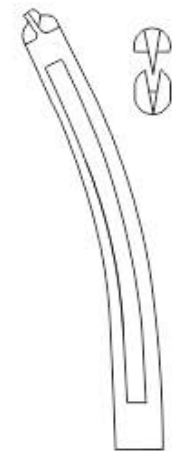

17-338
20 cm
Curved
Box Joint

PARAMETRIUM FORCEPS, HYSTERECTOMY FORCEPS

Parametriumklemmen, Hysterektomieklemmen
Pincas parametrium, Pincas à hystérectomie

Pinzas parametrium, Pinzas-clamps para histerectomia
Pinze parametrium, Pinze per isterectomia

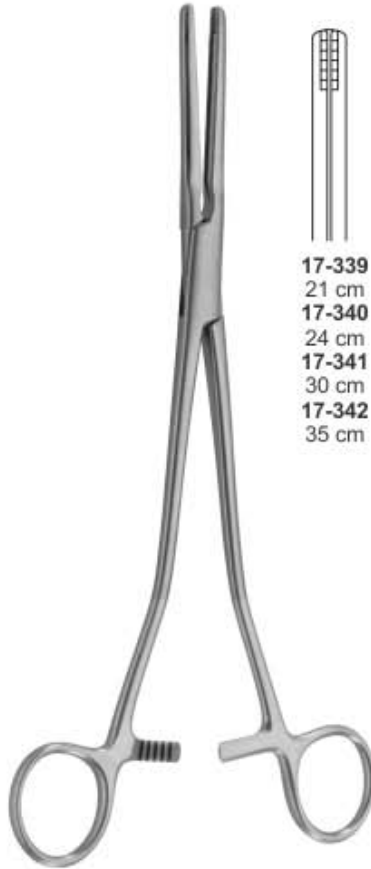

Parametrium Hysterectomy Forceps

17-339 21 cm	17-343 21 cm	17-347 21 cm	17-351 21 cm	17-355 21 cm
17-340 24 cm	17-344 24 cm	17-348 24 cm	17-352 24 cm	17-356 24 cm
17-341 30 cm	17-345 30 cm	17-349 30 cm	17-353 30 cm	17-357 30 cm
17-342 35 cm	17-346 35 cm	17-350 35 cm	17-354 35 cm	17-358 35 cm S-curved



Rogers Parametrium Hysterectomy Forceps

17-359 Fig. 1 22 cm	17-360 Fig. 2 21.5 cm	17-361 Fig. 3 21 cm	17-362 Fig. 4 20.5 cm
17-363 Fig. 1 25 cm	17-364 Fig. 2 25 cm	17-365 Fig. 3 24.5 cm	17-366 Fig. 4 23 cm

UTERINE DILATORS

Uterusdilatoren | Diladores uterinos
Dilatateurs utérins | Dilatori uterini



Hank Uterine Dilators 6 Set
17-367 Complete Set
Curved, Delicate, 11-12 Fr. to 21-22 Fr.
(3.66mm to 7.33cm)

Hank Uterine Dilators, Double-ended
17-368 11-12 Fr. (3.6mm x 4.0mm), 27.5cm
17-369 13-14 Fr. (4.3mm x 4.7mm), 27.5cm
17-370 15-16 Fr. (5.0mm x 5.3mm), 27.5cm
17-371 17-18 Fr. (5.7mm x 6.0mm), 27.5cm
17-372 19-20 Fr. (6.3mm x 6.7mm), 27.5cm
17-373 21-22 Fr. (7.0mm x 7.3mm), 27.5cm

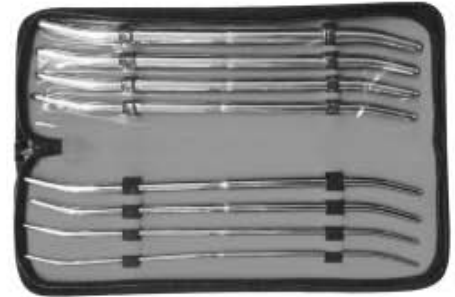

Pratt Uterine Dilators 8/Set
17-374 Complete Set
Curved, Delicate, 13-15 Fr. to 41-43 Fr., Straight

Pratt Uterine Dilators, Double-ended
17-375 13 / 15 Fr., 29.5cm
17-376 17 / 19 Fr., 29.5cm
17-377 21 / 23 Fr., 29.5cm
17-378 25 / 27 Fr., 29.5cm
17-379 29 / 31 Fr., 29.5cm
17-380 33 / 35 Fr., 29.5cm
17-381 37 / 39 Fr., 29.5cm
17-382 41 / 43 Fr., 29.5cm



Hegar uterine dilator
17-383 3 / 4 mm - 17 / 18 mm Ø
8 Pieces per set
17-384 1 / 2 mm - 25 / 26 mm Ø
13 Pieces per set

Hegar uterine dilator
17-385 1 / 2 mm Ø
17-386 3 / 4 mm Ø
17-387 5 / 6 mm Ø
17-388 7 / 8 mm Ø
17-389 9 / 10 mm Ø
17-390 11 / 12 mm Ø
17-391 13 / 14 mm Ø
17-392 15 / 16 mm Ø
17-393 17 / 18 mm Ø
17-394 19 / 20 mm Ø
17-395 21 / 22 mm Ø
17-396 23 / 24 mm Ø
17-397 25 / 26 mm Ø
double ended



Hegar Uterine Dilators 8 Set W/Roll
17-398 Complete Set
Curved, Delicate, 3mm to 18mm, Curved

Hegar Uterine Dilator, Double-ended
17-399 3mm & 4mm, (20cm)
17-400 5mm & 6mm, (20cm)
17-401 7mm & 8mm, (20cm)
17-402 9mm & 10mm, (20cm)
17-403 11mm & 12mm, (20cm)
17-404 13mm & 14mm, (20cm)
17-405 15mm & 16mm, (20cm)
17-406 17mm & 18mm, (20cm)

UTERINE DILATORS

Uterusdilatoren | Dilataores uterinos
Dilateurs utérins | Dilatori uterini

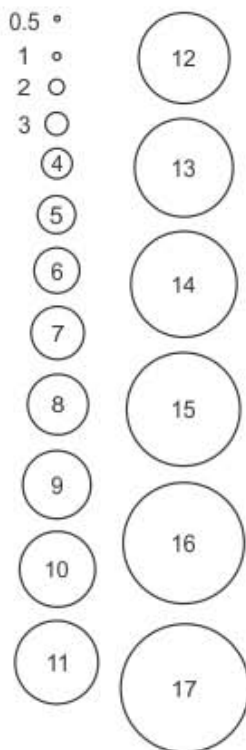

- 17-408 18.5cm 3-4-5mm
- 17-409 18.5cm 4-5-6mm
- 17-410 18.5cm 5-6-7mm
- 17-411 18.5cm 6-7-8mm
- 17-412 18.5cm 7-8-9mm
- 17-413 18.5cm 8-9-10mm
- 17-414 18.5cm 9-10-11mm
- 17-415 18.5cm 10-11-12mm
- 17-416 18.5cm 11-12-13mm
- 17-417 18.5cm 12-13-14mm
- 17-418 18.5cm 13-14-15mm
- 17-419 18.5cm 14-15-16mm
- 17-420 18.5cm 15-16-17mm
- 17-421 18.5cm 16-17-18mm
- 17-422 18.5cm 17-18-19mm
- 17-423 18.5cm 18-19-20mm
- Canvas Roll

Bonney-Barker Dilators
17-407 Set of 16 Pcs



- 17-425 27cm 9/10mm
- 17-426 27cm 11/12mm
- 17-427 27cm 13/14mm
- 17-428 27cm 15/16mm
- 17-429 27cm 17/18mm
- 17-430 27cm 19/20mm

Hank Double Ended
17-424 Set of 6 Pcs

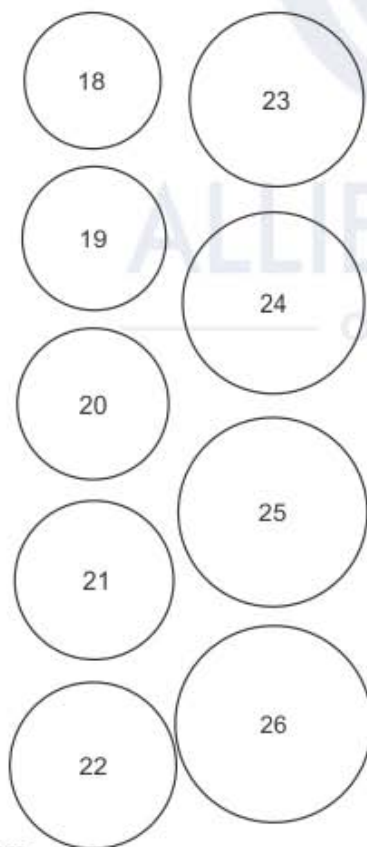

- 17-432 17cm 3-6mm
- 17-433 17cm 4-7mm
- 17-434 17cm 5-8mm
- 17-435 17cm 6-9mm
- 17-436 17cm 7-10mm
- 17-437 17cm 8-11mm
- 17-438 17cm 9-12mm
- 17-439 17cm 10-13mm
- 17-440 17cm 11-14mm
- 17-441 17cm 12-15mm
- 17-442 17cm 13-16mm
- 17-443 17cm 14-17mm
- 17-444 17cm 15-18mm
- 17-445 17cm 16-19mm
- 17-446 17cm 17-20mm
- 17-447 17cm 18-21mm
- Canvas Roll Only

Hawkin Ambler Dilators
17-431 Set of 16 Pcs



- 20cm 1/2mm
- 20cm 3/4mm
- 20cm 5/6mm
- 20cm 7/8mm
- 20cm 9/10mm
- 20cm 11/12mm
- 20cm 13/14mm
- 20cm 15/16mm
- 20cm 17/18mm
- 20cm 19/20mm
- 20cm 21/22mm
- 20cm 23/24mm
- 20cm 25/26mm
- 17-448 Set 8 Double Ended 3/4mm-17/18mm
- 17-449 Set 12 Double Ended 1/2mm-23/24mm
- 17-450 Set 8 Double Ended Canvas Only
- 17-451 Set 12 Double Ended Canvas Only

Hegar Double Ended Dilators

UTERINE DILATORS

Uterusdilatoren | Dilataores uterinos
Dilateurs utérins | Dilatori uterini



Hegar
with siped handle

Set	mm	pieces per set
17-452	4-17	14
17-453	1-26	26

17-454	1mm Ø	17-484	1.5mm Ø
17-455	2mm Ø	17-485	2.5mm Ø
17-456	3mm Ø	17-486	3.5mm Ø
17-457	4mm Ø	17-487	4.5mm Ø
17-458	5mm Ø	17-488	5.5mm Ø
17-459	6mm Ø	17-489	6.5mm Ø
17-460	7mm Ø	17-490	7.5mm Ø
17-461	8mm Ø	17-491	8.5mm Ø
17-462	9mm Ø	17-492	9.5mm Ø
17-463	10mm Ø	17-493	10.5mm Ø
17-464	11mm Ø	17-494	11.5mm Ø
17-465	12mm Ø	17-495	12.5mm Ø
17-466	13mm Ø	17-496	13.5mm Ø
17-467	14mm Ø	17-497	14.5mm Ø
17-468	15mm Ø	17-498	15.5mm Ø
17-469	16mm Ø	17-499	16.5mm Ø
17-470	17mm Ø	17-500	17.5mm Ø
17-471	18mm Ø	17-501	18.5mm Ø
17-472	19mm Ø	17-502	19.5mm Ø
17-473	20mm Ø	17-503	20.5mm Ø
17-474	21mm Ø	17-504	21.5mm Ø
17-475	22mm Ø	17-505	22.5mm Ø
17-476	23mm Ø	17-506	23.5mm Ø
17-477	24mm Ø		
17-478	25mm Ø		
17-479	26mm Ø		
17-480	27mm Ø		
17-481	28mm Ø		
17-482	29mm Ø		
17-483	30mm Ø		



Hegar Uterine Dilator
single ended
17-507 4 mm - 17 mm Ø
8 Pieces per set
17-508 1 mm - 26 mm Ø
24 Pieces per set



Hegar Uterine Dilator
single ended
17-509 4 mm - 17 mm Ø
24 pieces per set



17-510
20cm

GELPI
Vulva Self Retaining



DOYEN
Vaginal Flat Retractor
17-511
1.75mm x 10mm x 23cm



JOLL Thyroid Self Retaining
17-512 15.5cm



Forceps for I.U.D Removing
17-513
4 mm Ø x=230 mm



17-514
IUP Grasping Forceps 3 mm
22 cm



Schultze, Salpingograph
17-515 29.5 cm
complete in wooden case



17-516 5mm x 25mm
11.5cm
17-517 5mm x 50mm
14cm
17-518 5mm x 80mm
17cm
Cannula

HORMONE
Implant Trocar Set



17-519 6EG S/P
17-520 7EG S/P
17-521 8EG S/P
17-522 9EG S/P
17-523 10EG S/P
15.5 cm

FEMALE
Catherers



8EG 5mm
10EG 6mm
17-524 8EG S/P
17-525 10EG S/P
19cm

ROTUNDA
Catherers



FEMALE
Bladder Sounds
17-526 6EG S/P
17-527 8EG S/P
17-528 10EG S/P
17-529 12EG S/P
24cm

NEEDLE EXTENSIONS



LEUR
Needle Extensions
17-530 7.5cm
17-531 10cm
17-532 13cm



BOZEMAN
Dressing Forceps
27cm
Box Joint



17-533
Serrated



17-534
Grooved



17-535
Large Bow
Serrated



BONNEY
Vaginal Clamps
17-536
34.5cm
Screw Joint



VAGINAL
Dressing Forceps
17-537
24cm
Serrated

UTERINE SOUNDS

Uterus-Sonden

Histerómetros uterinos

Hystéromètres du col de l'utérus

Isterometri uterini



Sims Uterine Sound
17-538 32 cm
right, graduated in cm
17-539 32 cm
malleable graduated in cm



Sims Uterine Sound
17-540
33 cm
right, malleable



Sims Uterine Sound
17-541
32.5cm
Non-graduated



Sims Uterine Sound
17-542
32.5cm
Graduated in cm



Sims Uterine Sound
17-543
24cm
Graduated in cm



Sims-Special Uterine Sound
17-544
33 cm



Sims Uterine Sound
schwed. Modell
17-545
26 cm



Martin Uterine Sound
17-546 30 cm



Valleix Uterine Sound
17-547 25 cm



Mayo Uterine Sound
17-548 33 cm
biegsam malleable



Simpson Uterine Sound
17-549 29 cm
malleable silver-plated



Simpson Uterine Sound
17-550 32.5cm
Graduated in inches



SMELLIE
17-551
30 cm



Braun, Midwifery
Decapitating hook
17-552
32.5 cm



Suture Retrieval
Hook
17-553
27cm



Suture Retrieval
Hook
Sims Handle
17-554
27 cm



17-555
18cm
Fine
Colour
Coated



IRIS
Skin Hooks



IRIS
Skin Hooks

17-556
25.5cm
Fine
Colour
Coated



TENACULUM EMMETT



17-557
23cm
bic



17-559
18.5cm
bic



TENACULUM 3 PRONG



WHITTAKER



MYOMA INSTRUMENTS, FISTULA HOOKS

Myom-Instrumente, Fistelhaken

Instrumentos para fibroma, Ganchos para fistulas

Instruments pour myomes, Crochets pour fistules

Strumenti per miomi, Uncini per fistole



**Segond
Myoma Knife
Fistula Hook**
17-560
27 cm

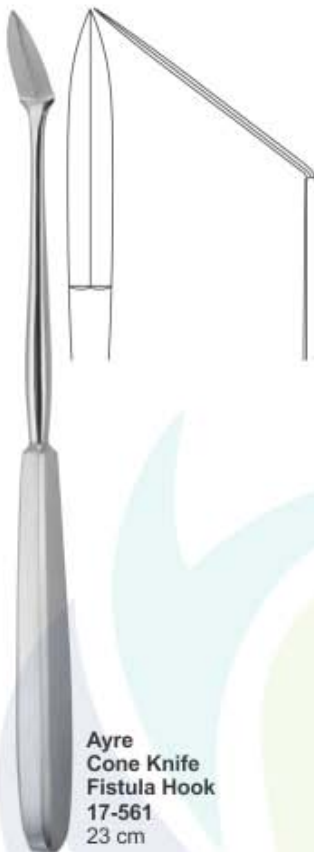

**Ayre
Cone Knife
Fistula Hook**
17-561
23 cm



**Doyen
Myoma Screw
And Fistula Hook**
17-562 14.5cm
17-563 17 cm



Fig. 1
17-564
22 cm

**Simon
Fistula Hook,
One Prong**



Fig. 2
17-565
22 cm

**Simon
Fistula Hook,
Two Prong**

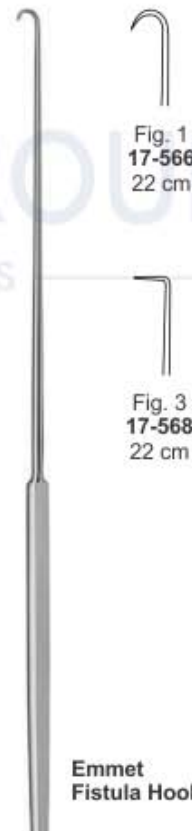

Fig. 1
17-566
22 cm

Fig. 3
17-568
22 cm

**Emmet
Fistula Hook**

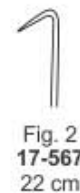

Fig. 2
17-567
22 cm

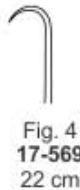

Fig. 4
17-569
22 cm

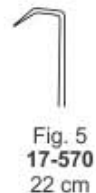

Fig. 5
17-570
22 cm



Uni - Randall
aspirating curette
17-571 4 mm Ø
24 cm



Novak
aspirating curette
17-576 4 mm Ø
23 cm

Mini - Novak
aspirating curette
23.5 cm
17-577 1 mm Ø
17-578 2 mm Ø
17-579 3 mm Ø



Uni - Randall
aspirating curette
17-572
30 cm
rigid, without basket



Uni - Randall
aspirating curette
17-573
30 cm
malleable,
without basket



Uni - Randall
aspirating curette
17-574
30 cm
rigid, with basket

Uni - Randall
aspirating curette
17-575
30 cm
malleable,
with basket









**Specimen And
Aspirating Curette**
20 cm
17-580 3 mm Ø
17-581 4 mm Ø
17-582 6 mm Ø
17-583 8 mm Ø
17-584 10 mm Ø
17-585 12 mm Ø
17-586 14 mm Ø



Coupling Piece
aspirating curette
12 cm
17-587

FLUSHING CURETTES

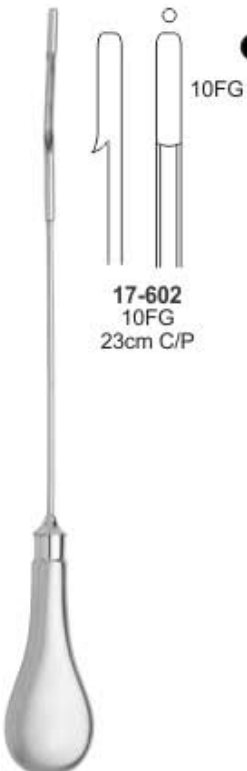
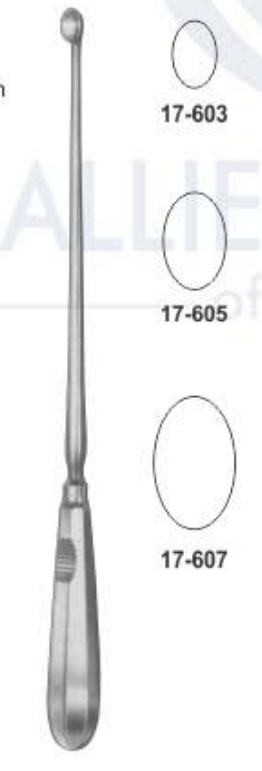
Küretten spülen | Curetas de lavado
Curettes de rinçage | Curette di lavaggio

 <p>17-588 Small 29cm 8mm Sharp</p> <p>17-589 Medium 29cm 11mm Sharp</p> <p>17-590 Large 29cm 14mm Sharp</p>	 <p>8.0mm</p> <p>17-591 Small 29cm 8mm Blunt</p> <p>17-592 Medium 29cm 11mm Blunt</p> <p>17-593 Large 29cm 14mm Blunt</p>	 <p>17-594 12 FG 4mm 25.5cm</p>	 <p>1mm 25.5cm 2mm 25.5cm 3mm 25.5cm 4mm 25.5cm</p> <p>1 ● 17-595 2 ● 17-596 3 ● 17-597 4 ● 17-598</p>	 <p>2mm 25.5cm 3mm 25.5cm 4mm 25.5cm</p> <p>2 ● 17-599 3 ● 17-600 4 ● 17-601</p>
<p>Rheinstadter Flushing Curettes</p>		<p>Leechwilkinson Suction Biopsy Curettes</p>	<p>Novak Suction Biopsy Curettes</p>	<p>Randall Suction Biopsy Curettes</p>
 <p>17-602 10FG 23cm C/P</p>	 <p>10FG 3.3mm</p> <p>17-603 17-604</p> <p>17-605 17-606</p> <p>17-607 17-608</p>	 <p>17-609 30 cm 1.2mm</p> <p>17-610 30 cm 4.0 mm Without Basket</p> <p>17-611 30 cm 4.0 mm With Basket</p>	 <p>17-612 30.5cm</p>	
<p>Sharman Endometrial Biopsy Curettes</p>	<p>SCHROEDER 30 cm, 12" sharp, rigid</p>	<p>KEVORKIAN</p>	<p>Kevorkian Endocervical Curettes With Basket Round</p>	

Uteruslöffel, Absaugküretten, uterusdepressor

Curettes uterines, curettes d'aspiration, Dépresseur utérin

Cucharillas uterinas, Curetas aspiradoras, depresor uterino

Curette uterine, curette pe aspirazione, depressore uterino



17-613
30.5cm

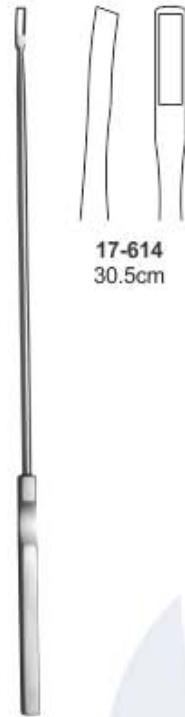

17-614
30.5cm



Braun Uterine Depressor
17-615 28 cm.



Blake Double Ended
17-616 24.5 cm
Sharp / Blunt

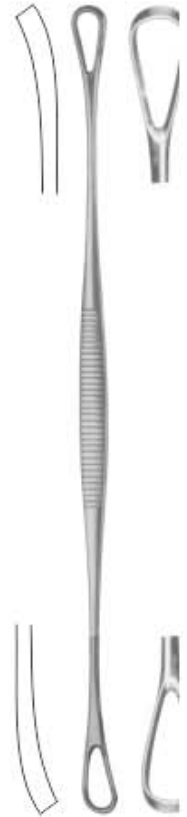

Zweifel Double Ended
17-617 24.5cm
Sharp / Sharp

Kevorkian Endocervical Curettes
With Basket Square

Kevorkian Endocervical Curettes
Without Basket Square



Coakley
17cm



17-618
Fig. 1



17-619
Fig. 2



17-620
Fig. 3



17-621
Fig. 4



17-622
Fig. 5



17-623
Fig. 6

ALLIED GROUP
of Industries

UTERINE CURETTES

Uterusküretten | Currettes uterinas
Currettes utérines | Curette uterine

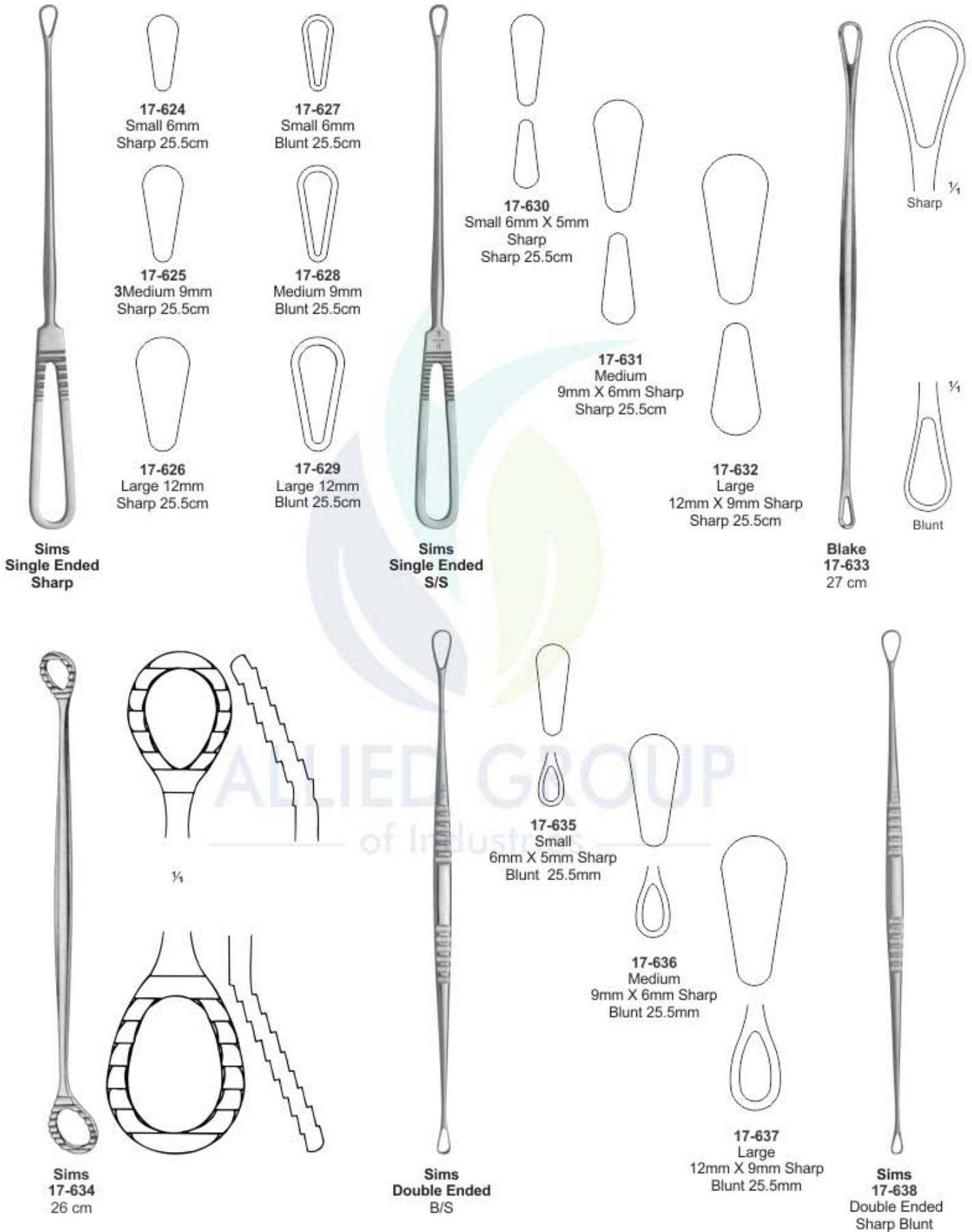



Recamier
uterine curette
y=26 cm

Fig.	x=mm	Sharp, malleable	Blunt, malleable	Sharp, rigid	Blunt, rigid
00	5	17-639	17-653	17-667	17-681
0	6	17-640	17-654	17-668	17-682
1	7	17-641	17-655	17-669	17-683
2	8	17-642	17-656	17-670	17-684
3	9	17-643	17-657	17-671	17-685
4	11	17-644	17-658	17-672	17-686
5	12	17-645	17-659	17-673	17-687
6	14	17-646	17-660	17-674	17-688
7	15	17-647	17-661	17-675	17-689
8	16	17-648	17-662	17-676	17-690
9	19	17-649	17-663	17-677	17-691
10	20	17-650	17-664	17-678	17-692
11	21	17-651	17-665	17-679	17-693
12	23	17-652	17-666	17-680	17-694

Recamier
uterine curette
y=31 cm

Fig.	x=mm	Sharp, malleable	Blunt, malleable	Sharp, rigid	Blunt, rigid
00	5	17-695	17-709	17-723	17-737
0	6	17-696	17-710	17-724	17-738
1	7	17-697	17-711	17-725	17-739
2	8	17-698	17-712	17-726	17-740
3	9	17-699	17-713	17-727	17-741
4	11	17-700	17-714	17-728	17-742
5	12	17-701	17-715	17-729	17-743
6	14	17-702	17-716	17-730	17-744
7	15	17-703	17-717	17-731	17-745
8	16	17-704	17-718	17-732	17-746
9	19	17-705	17-719	17-733	17-747
10	20	17-706	17-720	17-734	17-748
11	21	17-707	17-721	17-735	17-749
12	23	17-708	17-722	17-736	17-750

UTERINE CURETTES

Uterusküretten | Currettes uterinas
Currettes utérines | Curette uterine



Fig. 13



Fig. 14



Fig. 15



Fig. 16

Fig.	x=mm	Sharp, malleable
13	25	17-751
14	30	17-752
15	35	17-753
16	40	17-754

	Blunt, malleable
	17-755
	17-756
	17-757
	17-758

	Sharp, rigid
	17-759
	17-760
	17-761
	17-762

	Blunt, rigid
	17-763
	17-764
	17-765
	17-766

Recamier
uterine curette
y=34 cm



Fig. 1



Fig. 2



Fig. 3



Fig. 4



Fig. 5



Fig. 6

Fig.	x=mm
1	7
2	8
3	9
4	11
5	12
6	14

	Sharp, malleable
	17-767
	17-768
	17-769
	17-770
	17-771
	17-772

	Sharp, rigid
	17-773
	17-774
	17-775
	17-776
	17-777
	17-778

	Blunt, malleable
	17-779
	17-780
	17-781
	17-782
	17-783
	17-784

	Blunt, rigid
	17-785
	17-786
	17-787
	17-788
	17-789
	17-790

Sims
uterine curette
28 cm

UTERINE SPOONS

Scharfe Löffel

Cucharillas cortantes

Curettes tranchantes

Cucchiai tahlienti



Fig. 1
17-791
25 cm
Sharp, rigid



Fig. 2
17-792
25 cm
Sharp, rigid



Fig. 3
17-793
25 cm
Sharp, rigid



Fig. 4
17-794
25 cm
Sharp, rigid



Fig. 5
17-795
25 cm
Sharp, rigid



Fig. 6
17-796
25 cm
Sharp, rigid

**Schröder
Uterine Spoon**



Fig. 1
17-797
30 cm



Fig. 2
17-798
30 cm



Fig. 3
17-799
30 cm



Fig. 4
17-800
30 cm

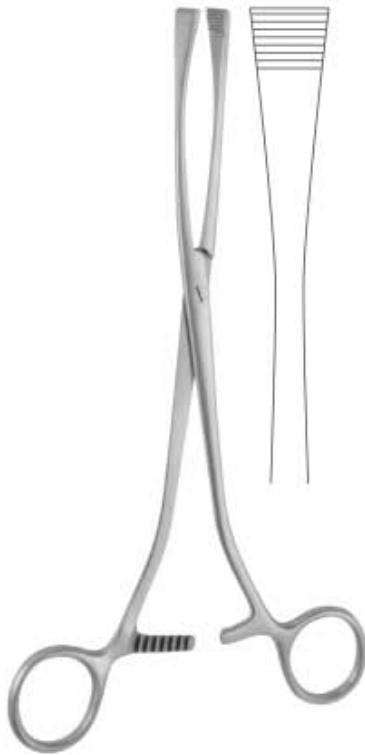

Fig. 5
17-801
30 cm



Fig. 6
17-802
30 cm

**Schröder
Uterine Spoon**



Green-Armytage
Uterine Elevating Forceps
17-803 21 cm



Smellie
Obstetrical Forceps
17-804 25 cm
Perforator



NAEGELE
17-805
25 cm

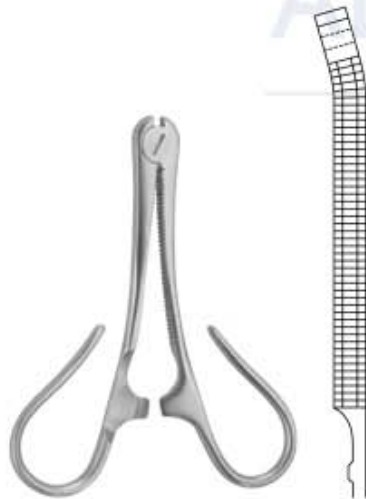

Kane
obstetrical forceps
17-806
8.5 cm



Collin
Obstetrical Forceps
17-807
9 cm



Zimmerman
Myotome,
Spoon Tip,
17-808
24 cm



Zimmerman
Myotome,
Chisel Tip,
17-809
29 cm

ALLIED GROUP
of Industries

Abortuszangen - Abortusküretten

Pinzas para abort - Curetas para aborto

Pinces à faux germes - Curette d'avortement

Pinze per placenta ed aborto - Curette per placenta ed aborto

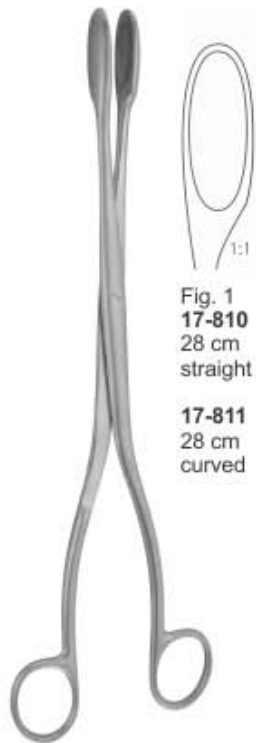

Winter
abortion forceps

Fig. 1
17-810
28 cm
straight

17-811
28 cm
curved



Fig. 2
17-812
28 cm
straight

17-813
28 cm
curved

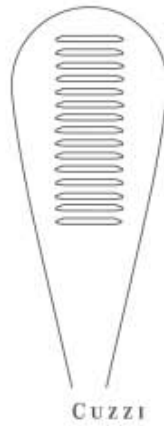

Fig. 3
17-814
28 cm
straight

17-815
28 cm
curved



Cuzzi
ovum curette
blunt, back serrated



C U Z Z I



14.5 mm
17-816
30 cm



18 mm
17-817
30 cm



21 mm
17-818
30 cm



Saenger
Abortion Forceps



17-819
27 cm
Straight

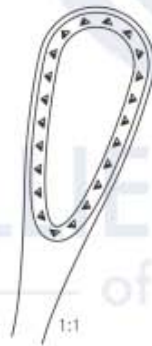

17-820
27 cm
Curved



Wallich
ovum curette
17-821 42 cm



1:1



Pestaloza
Ovum Curette
17-822 30 cm



1:1

PELVIMETER, OBSTETRICAL FORCEPS

Beckenzirkel, Geburtszangen | Pelvímetro, Forceps obstétricos
 Pelvimètre, Forceps obstétriques | Pelvimetri, Forcipi obstetrici

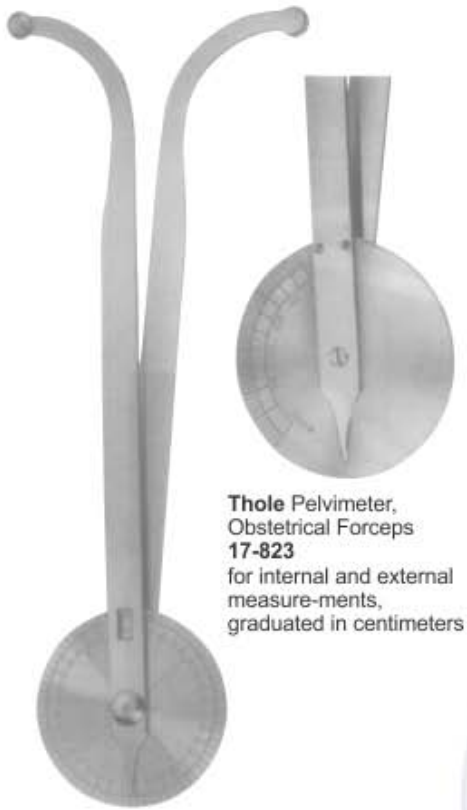

Thole Pelvimeter, Obstetrical Forceps 17-823
 for internal and external measurements, graduated in centimeters



De Lee Pelvimeter, Obstetrical Forceps 17-824
 graduated in centimeters and inches

for internal measurements between symphysis and promontory



Collin Pelvimeter, Obstetrical Forceps 17-825
 Graduated in Centimeters



Martin Pelvimeter, Obstetrical Forceps 17-826
 graduated in centimeters



Collin Pelvimeter, Obstetrical Forceps 17-827
 graduated in centimeters

The additional straight arm can be replaced. The pelvimeter with straight arm is used for localisation of the portio vaginalis uteri and of vaginal metastasis.



Breisky Pelvimeter, Obstetrical Forceps 17-828
 graduated in centimeters



Simpson
Obstetrical Forceps
17-829 23 cm
17-830 30 cm
17-831 33 cm
17-832 36 cm



Simpson - Braun
Obstetrical Forceps
17-833 33 cm
17-834 36 cm



Naegele
Obstetrical Forceps
17-835 36 cm
17-836 40 cm



Piper
obstetrical forceps
17-837 44 cm



Simpson - Luikart
Obstetrical Forceps
17-838 36 cm



Wrigley
Obstetrical Forceps
17-839 25 cm
17-840 28 cm
for caesarian section



De Lee
obstetrical forceps
17-841 30 cm



De Lee
obstetrical forceps
17-842 36 cm
17-843 15 cm



Elliot
obstetrical forceps
17-844 32 cm
17-845 38 cm

OBSTETRICAL FORCEPS

Geburtszangen

Forceps obstétricos

Forceps obstétriquus

Forcipi



McLean
obstetrical forceps
17-846 36 cm



Kielland
Obstetrical Forceps
17-847 41 cm



Kielland-Luikart
obstetrical forceps
17-848 40 cm



Barnes-Neville
17-849 40 cm
Simpson handles, detachable
axis traction rod and handle.



**Bil Obstetrical
Holder**
17-850



Barnes-Neville
Obstetrical Forceps
17-851
with traction
handle 43.5 cm



Braun
obstetrical forceps
17-852
42 cm
Cranioclast, one
jaw fenestrated



Tarnier
obstetrical forceps
17-853
46 cm
Basiotribe



Sellheim
Obstetrical Lever
17-854
28 cm